

Data Sheet



Article number: 2302083851

Description: E+G Lock knob
VTR.50 p-M10x20

Measures

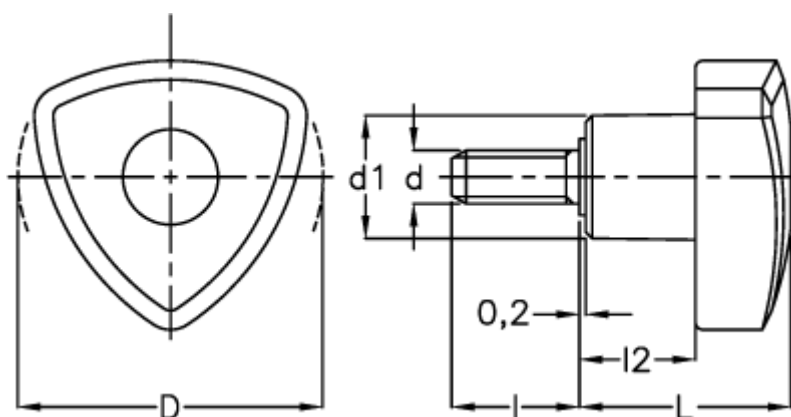

d	=	50
d1	=	19
d 6g	=	M10
l	=	20
L	=	35
l2	=	19